

Powerware series

20-160 kVA

Eaton 9390 UPS



Powering Business Worldwide

Eaton 9390
20-160 KVA

Innovative design delivers industry-leading power performance

The Eaton® 9390 uninterruptible power system (UPS) is a double-conversion UPS that resolves all utility power problems and supplies clean, continuous, uninterruptible power to connected equipment. Whether you're selecting a UPS for a branch office, manufacturing floor, medical facility, or data center, there's a 9390 model that delivers just the right combination of performance and price for your needs.

Applications

The 9390 delivers centralized backup support and protection for the following types of applications:

- Mid-size data centers
- Medical facilities
- Schools
- Broadcasting, including TV, radio, cell and remote stations
- Factory/industrial such as PCs, critical machinery and operations
- Pharmaceuticals
- Mid-size office buildings (PCs, network, phone, storage and server rooms)
- Medium size retail (phone systems, office PCs, POS)
- Hotels and casinos
- Banking
- Co-location data center facilities



20-80 kVA



100-160 kVA

Benefits

- Leading sustainability
 - Highest efficiency ratings lower utility costs
 - Lowest total cost of ownership and lifecycle carbon footprint
 - Smallest footprint and weight
 - Lowest transportation and installation costs
- Stronger power performance
 - Lowest input THD enhances compatibility with upstream power systems
 - Lowest output THD
 - Optimum generator sizing
 - PFC power supply compatibility
 - Widest voltage range offering
- Highest reliability and availability
 - Powerware Hot Sync® wireless paralleling
 - Superior battery management
 - Inherent redundancy
 - Scalable architecture adapts to increasing power requirements
- Robust manageability
 - Superior control and connectivity

Energy efficiency means substantial cost savings

All UPSs consume energy to operate, and some unused energy is dissipated as heat as it passes through the UPS—the more heat and dissipated energy, the higher cost of operation. The efficiency rating of a UPS measures how little energy is wasted. For example, a 90% efficient UPS delivers 90 kW of useful power for every 100 kW taken in. With a transformerless design and sophisticated sensing and control circuitry, the 9390 delivers an efficiency of up to **94 percent** with double-conversion protection. In addition to the cost savings, this enhanced efficiency extends battery runtimes and produces cooler UPS operating temperatures, extending component life and increasing reliability and performance.

Comparison of 90% versus 94% efficient 80 kVA UPS

Percent efficiency	Wasted kW hours*	Cost per kWh and demand	Extra energy cost	Extra air conditioning cost	Annual savings vs. less-efficient model
90	63,072	\$0.13	\$8,199	\$5,740	
94	37,843	\$0.13	\$4,919	\$3,444	\$5,576

* Mostly dissipated as heat.

Operational savings

Efficiency comparison

Efficiency difference:	2%		3%		4%	
	1 year	5 years	1 year	5 years	1 year	5 years
Savings—80 kVA UPS	\$2,788	\$13,940	\$4,182	\$20,910	\$5,576	\$27,880
Savings—160 kVA UPS	\$5,576	\$27,880	\$8,363	\$41,815	\$11,151	\$55,755
CO ₂ Savings—80 kVA	19.3 tons	96.5 tons	23.1 tons	115.5 tons	26.9 tons	134.5 tons
CO ₂ Savings—160 kVA	26.9 tons	134.5 tons	34.5 tons	172.5 tons	42.2 tons	211 tons

Eaton 9390 160 kVA Efficiency Curve

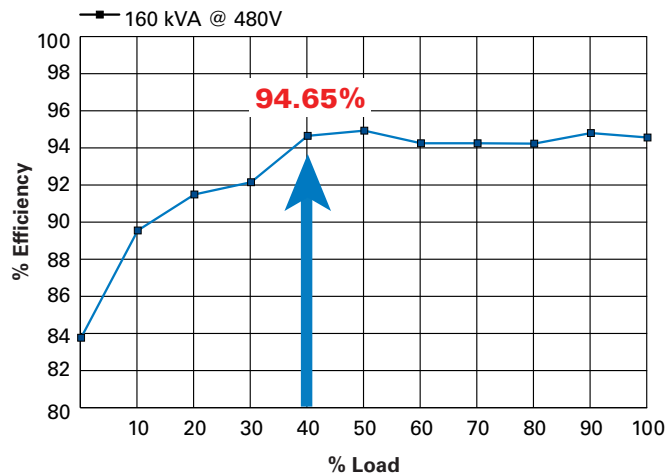

Power performance

	Input THD	Output PF	Efficiency
Eaton 9390	<4.5%	0.9	94%
Competitor "A"	<7.5%*	0.8	92.5-93%
Competitor "B"	<10%*	0.8	90-95%
Competitor "C"	<10%*	0.8	92-93%
Competitor "D"	<7%*	0.8	87-93%
Competitor "E"	<7%*	0.8	90-93.3%
Competitor "F"	<3%	0.8	88.5-94%
Competitor "G"	<3-7%	0.8	87% (estimated)

*w/filter (-30% w/out)

Alternative voltages for IT data center powering

In addition to conventional (208 and 480) voltage capabilities, the 9390 now has the ability to support direct-connect 400/230 Vac for powering directly to the IT rack. This capability allows for the deployment of a UL/CE rated UPS that can protect and distribute 400/230 Vac directly to IT racks without an additional step-down transformer. Some of the efficiencies and benefits of this alternative voltage powering are:

- Elimination of the step-down 480-208 volt transformer lowers heat losses and saves valuable floor space in the data center
- Higher voltage directly to IT equipment allows it to operate at higher efficiency (no changes required, as virtually all servers are rated to operate at up to 240 Vac)
- No changes to power distribution equipment since connectors and circuit breakers already exist with these ratings
- The use of Eaton's high efficiency 9390 UPS in such an application further improves system overall efficiency.
- Multiple studies show that up to 5% overall efficiency gains can be made versus equivalent 480 or 208 Vac systems, resulting in thousands of dollars in savings per year.

Consistent efficiency throughout UPS load range

Many UPSs cite greater than 90% efficiency without mention of low or no load range. Today's average system operates at only 55% of its rated load or capacity range. However, efficiency is usually reduced in this lower-load operating status—not so with the 9390, which reaches optimal efficiency rates at less than half load—and maintains this optimal efficiency throughout the load range!

Low input current THD enhances generator compatibility

Electronic devices and UPSs are built with some components that are non-linear. When voltage is applied to a circuit constructed of non-linear components, the circuit may not respond linearly (current may not follow the voltage in a linear manner). These components may even create frequencies other than the fundamental applied frequency (60 Hz).

These frequencies (harmonics) occur in odd multiples of 60 Hz. The degree of occurrence is called total harmonic distortion (THD). If the power source can't respond to all frequencies demanded by the circuit, then further distortion of the applied voltage may occur—creating more complication. Every UPS produces a level of harmonics. Unchecked, harmonics can reduce overall power factor, cause sensitive devices to malfunction, prematurely age equipment, and cause screens and displays to flicker.

To avoid these negative effects, the 9390 uses a special input circuit that keeps current THD at less than 4.5% at full load—without compromising efficiency. As a result, the 9390 transfers maximum power between the source and protected load and is exceptionally compatible with multiple power sources, especially auxiliary generators. In the Power Performance chart on the previous page, note that most manufacturers require an input filter to minimize THD. This added filter results in lower efficiency for the UPS—a consequence not generally noted in marketing materials.

Power factor performance maximizes compatibility and meets high power factor load requirements

Power factor (PF) describes the slight phase shift between voltage applied to a circuit and current that the circuit draws in response to the applied voltage. The maximum power factor possible is unity (1.0), or no phase shift between the voltage applied and the circuit current response—maximum transfer of power between source and load. However, in the real world, the UPS must be able to accept power from and deliver power to circuits that have a wide range of power factors.

Older or worn equipment often results in lower power factor readings. Some new servers operate at unity power factor. Lightly loaded facilities such as brand new data centers, can often show leading power factor readings.

On output, the ultra high-speed switching pulse width modulation (PWM) inverter enables the 9390 to provide its full rated power capability to the load, down to 0.9 leading power factor without de-rating.

Double-conversion design offers highest available protection

Unlike other commercially available UPS technologies, the double-conversion design completely isolates output power from all input power anomalies and delivers 100% conditioned, perfect sine wave output—regulating both voltage and frequency, providing protection from all nine common power problems.

Due to the 9390's built in high-efficiency capability, it operates in a consistent, efficient status without compromising power protection. Even when presented with the most severe power problems, power output remains stable with the 9390. Output voltage THD is held within two percent of nominal specification for linear loads, within five percent for non-linear loads—making the 9390 ideal for supporting equipment that is sensitive to a distorted voltage input as a result of harmonic loads. In the event of a utility power failure, there is no delay transferring to backup power.

LOAD Power Factor RANGE Chart

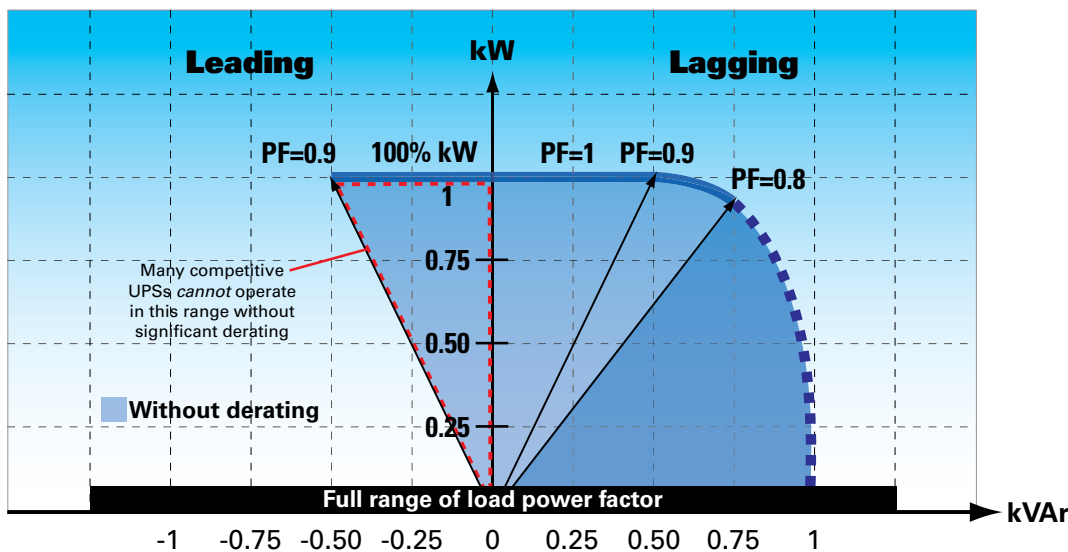

Scalable architecture meets your current and future load requirements

The 9390 supports up to 160 kVA to deliver power protection for small branch offices to large corporate data centers and communication networks. Up to six equivalent 9390 modules can be paralleled for additional capacity or redundancy, without having to utilize a central bypass cabinet. In all paralleling configurations, each UPS module operates independently yet is completely synchronized with the others. Parallel UPS modules can provide N+1, N+2, or greater redundancy.

Powerware Hot Sync wireless paralleling technology for capacity or redundancy

This two-module system shown below can be configured as 160 kVA N+1 redundant (320 kVA capacity with 36-inch tie cabinet). The width of this configuration is a compact 164.6 inches.

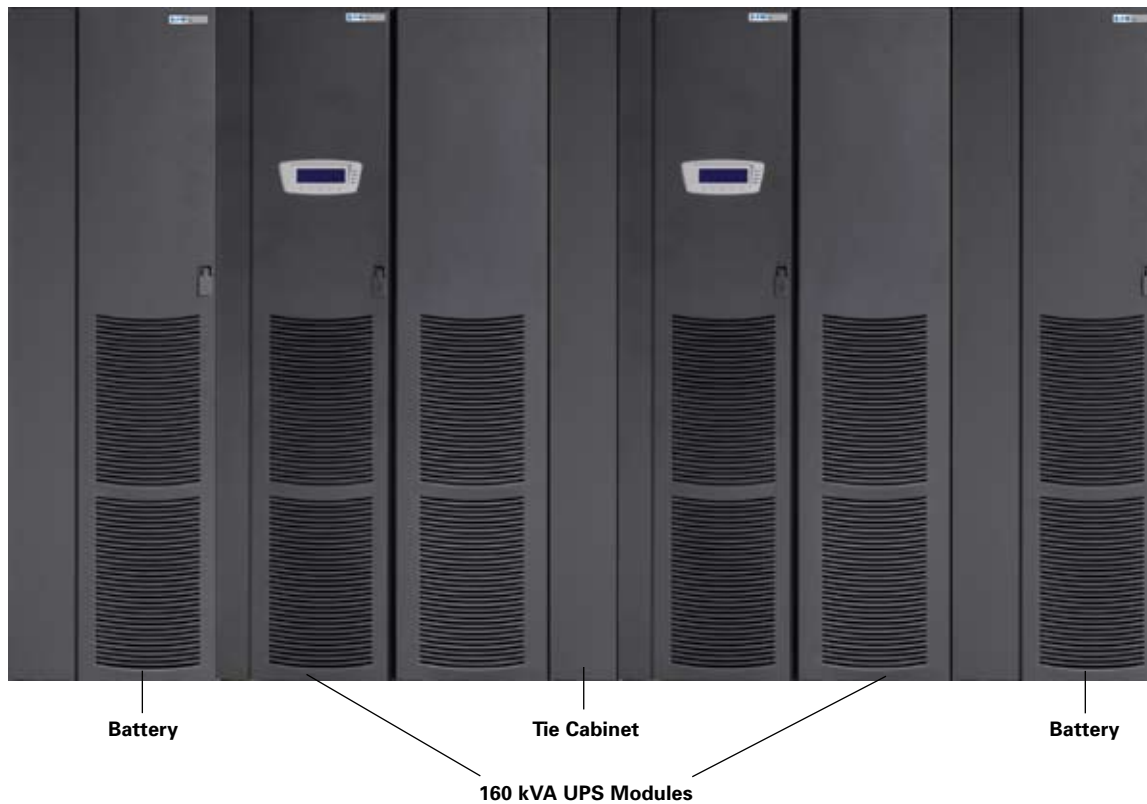

Powerware Hot Sync technology: The culmination of power reliability

Eaton's patented Powerware Hot Sync technology enables multiple UPSs to share the load equally, eliminating the transfer time when shifting the load from one module to the other. The load share control algorithms maintain adjustments to variations in the output power requirements.

When two or more UPSs operate in parallel for capacity and redundancy, Hot Sync addresses the two primary concerns of load sharing and selective tripping.

To address these concerns for reliability – the degree of autonomy and the complexity of implementation – Hot Sync combines digital signal processing and an advanced control algorithm to provide automatic load sharing and selective tripping in a parallel system, as well as complete autonomy of the modules and a skillfully simple implementation. The 9390 achieves optimum reliability and flexibility with the following design features:

- Unlike other paralleling techniques, there is no system-level single point of failure
- Hot Sync systems are capable of paralleling for both redundancy and capacity

- By using a peer configuration as opposed to a master-slave configuration, Hot Sync ensures that each module is operating independently
- No added circuitry or components are required to be switched in to operate in parallel
- With thousands of successful systems installed globally, Hot Sync is a proven technology
- The output of multiple UPSs remains in phase so that static transfer switches connected between the separate distribution paths may change state seamlessly when necessary

Each parallel unit operates with its own battery string – if any unit goes offline or is taken down for maintenance, the remaining units support the load fully with their battery capabilities. If any battery string fails, the remaining strings continue to support the load – thus eliminating a key potential single point of system failure.

Static Auto Tie

The Static Auto Tie (SAT) system enhances reliability even further so full load transfers can be made autonomously. SAT adds a wrap-around static switch to the tie breaker in the Hot-Tie system, then adds intelligent controls so a power protection system made up of two or more separate UPS systems can automatically transfer entire loads in the event of traumatic, catastrophic failure or one system – a rare but costly circumstance.

In the SAT configuration displayed in the diagram below, there is a Hot-Tie circuit between the outputs of the two UPS modules that automatically transfers the loads from one to the other as necessary. This less complex, dual path architecture streamlines the distribution system to eliminate series switching and reduce the potential downtime of single power cord loads by up to 50 percent. As a result, the SAT architecture offers a number of benefits, including:

- Reduced capital expenses
- Eliminates need for traditional downstream static transfer switches
- Reduced installation costs
- Increased system reliability and efficiency
- Decreased maintenance requirements
- Reduced raised floor space requirements

Advanced battery management optimizes battery performance and service life

Eaton's ABM® technology uses a unique three-stage charging technique that significantly extends battery service life and optimizes recharge time, compared to traditional trickle charging. An integrated battery management system tests and monitors battery health and remaining lifetime, and provides advance notification to guide preventive maintenance. Optional temperature-compensated charging monitors temperature changes and adjusts the charge rate accordingly to properly charge the

battery and greatly extend battery life. A variable battery bus accommodates 384 to 480V (192-240 cell) configurations, so the battery capacity can be matched to your exact runtime requirements—either a specific runtime, an extension to existing battery runtime, or utilization of legacy battery installations.

With remote monitoring of the UPS and battery system, Eaton is there with you—able to respond to alarms and see real-time battery data to avert potential battery problems.

Fully Deployed Static Auto Tie Configuration

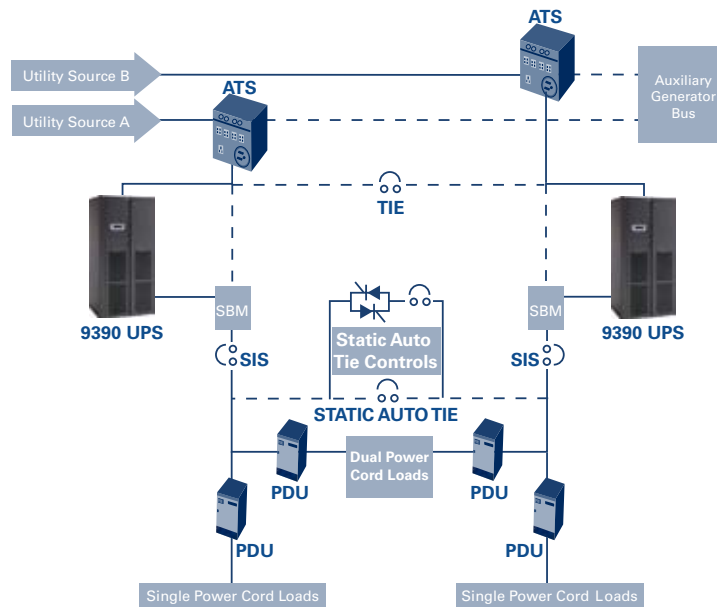

Flexible installation options expedite deployment and save valuable space

The 9390 offers the smallest footprint of any UPS in its class—35 to 50 percent smaller than competitive units. Cabling can enter the UPS from either the top or bottom of the cabinet to provide easier and flexible installation. The 9390 provides front panel access for all services and operation, increasing serviceability and reducing mean time to repair (MTTR). And since the compact 9390 cabinet can be installed against back and side walls, you have more location options, installation is fast and easy, deployment cost is lower, and you save valuable data center space.

Weight

At \$.30 per pound, the 9390 averages a cross-country freight savings of over \$630. With a transformerless design, Eaton UPS solutions meet or exceed virtually all floor loading standards. And with this lower weight, units can be moved without heavy capital equipment and can fit in all standard freight elevators.

Space savings

With a footprint of 597 square inches, the 9390 is a fraction of the 1281 square inches that

the competition takes up. With a manageable size, including a compact 72-inch height, the 9390 fits through most doors with ease, and requires no dismantling to get it to its final installation location.

Retrofit applications

The 9390 is perfect for retrofit operations. When an existing UPS is exceeding capacity but has no room to expand, or when the service contract is expiring, the existing UPS can be removed and replaced with a 9390 that offers more power in less space.

Big power, small footprint

Eaton 9390
Weight = 580 pounds
18.9 x 31.6 in.

Competition's
Weight = 2700 pounds
32.5 in. x 34.9 in.



Serviceability and accessibility

Being a pre-wired, integrated module, the 9390 saves time and cost of installation and cabling expenses because of standard top or bottom entry design. And with front access, the 9390 can be placed in a corner or against a wall—easily available for service and saving valuable space.

Internal scalability

Upgrading a 9390 is as simple as a phone call to an Eaton service technician to request an internal upgrade. For example, a 40 kVA unit can be field upgraded to an 80 kVA, and a 100 kVA unit can be upgraded to a 160 kVA—all performed onsite and without costly additional cabinetry and connections. This feature allows you to plan electrically for growth and eliminate future cabling costs.



Industry-leading warranty and service plans deliver peace of mind

Eaton recognizes that superior reliability requires flawless execution from its services team. Every 9390 includes an onsite start-up from a factory-trained field technician to ensure proper installation, operation and customer training. In addition, we include a full year of onsite 7x24 parts and labor warranty and service protection plan coverage at no extra cost. Included at no extra charge with every new 9390:

- 7x24x365 startup service and customer training
- One-year limited factory warranty*

- Service protection plan 7x24 coverage, eight-hour response (upgrade to four – or two-hour where available), parts, labor and unlimited on-site emergency response support
- eNotify Remote Monitoring service: 7x24 critical alarm notification and monthly reports on UPS battery health
- 7x24 technical support access

In addition to the warranty and first year of on-site coverage, Eaton offers a wide variety of support agreements for continued preventive and emergency response maintenance. PowerTrust™ Service Plans include:

- UPS and battery scheduled preventive maintenance

- Parts and labor coverage for electronics and/or batteries
- Factory-trained technicians with genuine Powerware parts and diagnostic tools
- eNotify Remote Monitoring service
- Available coverage: 7x24, eight/four/two-hour response, or 8x5 next business day response
- 7x24 technical support access

* Refer to the Eaton Corporation Limited Factory Warranty for Eaton three-phase UPS products for specifications, limitations and terms. Service and support specifications may vary by country.

eNotify Remote Monitoring service

All PowerTrust Service Plans include Eaton's eNotify Remote Monitoring service, enabling Eaton service technicians to remotely monitor your UPS and batteries. With technical experts available to respond immediately and resolve many issues remotely, eNotify features 7x24 real-time monitoring of 100+ UPS and battery alarms.

The eNotify service provides you with monthly e-mail reports detailing the ongoing health of your 9390 UPS. The customer monitoring report delivers information on your unit's voltages, loads and external factors such as temperature and humidity. Additionally, the report provides information about the attached batteries and system availability. All of these factors contribute to the Relative Health Index (RHI) score that allows you to compare your unit's health to Eaton's optimum UPS operating levels.

Proactive monitoring is also included. Upon receipt of both status and event e-mails, anomalies are checked for incoming parametric or event data logs. If an anomaly is detected, Eaton analysts further study the data for possible impending failures and take appropriate action. The following critical alarms are provided by eNotify:

- UPS output power will turn off after the configured delay period
- Low battery alarm present
- UPS hardware fault detected
- UPS battery completely discharged
- UPS inverter fault detected
- UPS internally bypassed
- UPS output has been turned off
- UPS shutdown imminent alarm condition exists
- The failure of one or more fuses has been detected
- A relay, contactor or breaker has failed

The eNotify Remote Monitoring Service provides confidence that Eaton is continually watching your 9390 and will combine its technical resources and field technicians as needed to quickly respond to critical alarms.

Eaton's total PowerChain Management solution

Eaton views your power system as a strategic asset – an approach we call PowerChain Management®. Eaton's PowerChain Management solutions can help transform complicated power systems into a single, integrated system easily visible and manageable as a strategic business asset, providing a significant competitive advantage.

If your company is like most, its power system was built over time. As the organization's needs changed, additional equipment was likely retrofitted into the system, with a circuit breaker added here and a transformer replaced there. The result can be a power system that is a complicated mixture of old and new equipment from several different manufacturers. Because there is no common means of communicating across varied equipment, gathering data across the enterprise can be quite challenging.

Power Xpert Architecture

The complexity of gathering data among various devices makes it difficult to get a clear picture of what's happening inside your power system, which decreases your ability to manage your power system effectively. Consequently, business results suffer, because your enterprise depends on its power system.

Eaton's Power Xpert® Architecture, the backbone of our PowerChain Management solutions, enables you to monitor much more than your 9390 UPS; it transforms your power system into an integrated, agile system that delivers real competitive advantages. With the software and hardware components of Power Xpert Architecture, you can monitor, control, and manage your

complete power system effectively and efficiently, including PDUs, batteries and other critical equipment. Using a simple, Web-based interface, the varied elements of your power system are integrated into a single view, with the ability to easily monitor the availability and reliability of electrical power, lower energy costs, extend equipment life, and more.

Optimize your power system

PowerChain Management can also help you manage your power system for peak performance by integrating and optimizing your power assets and ensuring that they align with your business goals.

Once your power system is linked to an Ethernet network via the Power Xpert Architecture, you can connect to and share information with a variety of applications, such as the building management system monitoring your HVAC equipment, or your enterprise accounting system. Power Xpert Architecture's open standards and scalable approach make it easy for your power system to grow and adapt to a rapidly changing environment.

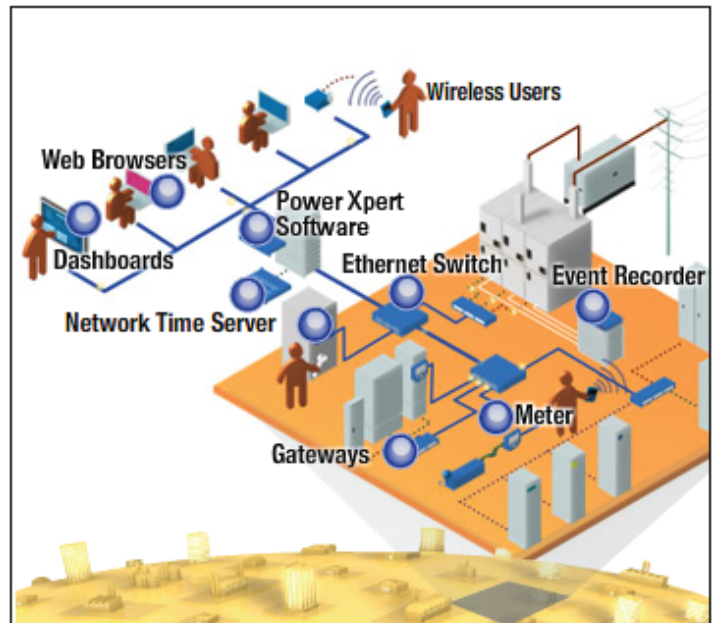

Power Xpert Software is designed to take the complexity out of managing your power system and provides a clear picture of what is happening at a component, device and system level.

Specialized applications

The 9390 isn't just an industry-leading UPS – it also serves in specialized capacities across the globe. With its lightweight design and minimal footprint, it is used in a variety of applications where mobility is a requirement.

Power conditioner

The 9390 is a double-conversion power conditioner that resolves utility power problems and supplies clean, continuous, regulated power to connected equipment. Whether you're selecting a power conditioner for a branch office, manufacturing floor, medical facility or a large data center, there's a 9390 model that delivers just the right combination of performance and price for your needs.

Medical imaging and equipment protection

Having been tested and certified for use in medical imaging system applications by all major suppliers of X-ray, MRI, and CT machines, the 9390 medical imaging version is specifically designed to protect these critical machines.

Frequency converter

The 9390 can be configured to operate as a frequency converter for specialized applications where protected power is required and conversion from 50 to 60 Hz or 60 to 50 Hz is needed for system operation. For example, the 9390 can act as a frequency converter in North American applications where European electrical equipment is being used or where North American equipment is deployed internationally.



The 9390 can be used without batteries as a power conditioner.



The 9390 is designed to handle loads that can go from a minimal 5 kVA to 130 kVA instantly when a medical image is taken, for example.

Integrated Battery Cabinet (IBC)

Eaton offers two versions of battery cabinets which line-up and match the 9390; the IBC-S and the IBC-L, each offering a wide array of runtimes. See powerware.com/9390 for options and runtime calculations.

Flexibility

- A variable battery bus accommodates 384 to 480V configurations, so the battery capacity can be matched to your exact runtime requirements – either a specific runtime, an extended runtime, an extension to an existing battery, or legacy battery installations
- Daisy chain up to four cabinets together for extended runtimes
- Integral, line-up-and-match configurations are standard
- Remote configurations are available
- Powerware brand batteries are available with a three-year warranty; other battery configurations are available with a one-year warranty

Serviceability

- Front access only design and top/bottom cable entry provides installation flexibility and enhances servicing
- Modular, removable battery tray design and quick disconnects between tray assemblies optimizes periodic maintenance
- Variable battery bus allows the system to be reconfigured temporarily to maintain operation while replacement batteries are obtained

Reliability

- Battery cabinets are UL 1778 listed
- Flame retardant batteries meet UL94V2 for computer room installation
- DC-rated circuit breaker in each cabinet allows multiple battery strings to be serviced independently of each other, assuring backup power is always available to the UPS
- Circuit breaker features UVR trip auxiliaries for system EPO and UPS sensing of battery breaker



IBC-S with door opened



IBC-L with doors opened



**40-80 kVA IDC Bypass/transformer/
distribution cabinet**

Features

- Two, three or four-breaker maintenance bypass
 - Transformer options up to K20
 - (2) 42-pole panelboards
- Or
- (1) 42-pole panelboard and up to (3) 250A distribution breakers
- Or
- Up to (6) 250A distribution breakers
 - Line and match or remote
 - Casters and leveling feet
 - Panelboards come with individual 225A main breaker
 - Neutral rated for harmonic loads (200%)
 - Distribution breakers are Eaton JG electronic trip
 - Two electronic sensors available 100A and 250A
 - 100A settings 40-100A trip (eight settings)
 - 250A setting 100-250A trip (eight settings)

Integrated Distribution Cabinet (IDC)

The Eaton IDC is specifically designed to compliment the 9390. With this optional cabinet, Eaton offers a complete, one-stop shop for power protection and distribution solutions that is easy to design, install, customize and manage – while delivering pay-as-you-grow scalability for future expansion.

Pre-configured for ease of use, mix-and-match for flexibility

The IDC is pre-configured with the most popular power distribution options for ease of design and installation. In addition, the IDC also offers the flexibility to mix and match power distribution, voltage transformation and maintenance bypass options to select the right combination of the following capabilities for your data center requirements:

- Power distribution options enable you to distribute power to servers or racks via distribution panelboards or distribute power to larger loads via distribution circuit breakers or terminal blocks.
- Voltage transformation allows you to change output voltage levels. For instance, you could convert 480 Vac output from the UPS into 208/120 Vac output from the UPS to serve data center loads. K-rated transformers are available to support loads with high harmonic content.

- Maintenance bypass enables power to completely bypass the UPS power module. You can then service or replace the module in complete safety, without interrupting power to critical systems.

Maintenance bypass is internally wired at the factory inside the IDC so that only input cables and UPS connections need to be made in the field.

Simplified installation and clean appearance

The IDC has the same look and finish as the 9390 it complements. The cabinet is shipped with interconnecting cables for fast and easy installation. The result is a clean look that enhances the appearance of your data center.

Integrated management and support for enhanced confidence

The 9390 and the IDC can all be monitored and managed by LanSafe®, PowerVision®, and FORESEER® software. This close integration provides greater visibility to your complete power protection and distribution structure.

Eaton backs up the IDC with the same one-year limited factory warranty* we offer on the 9390 UPS models. You can have both the confidence that both your power protection and distribution are supported by Eaton's best-in-class service organization and strong customer service commitments.

* See the Limited Factory Warranty for 9390 products for details.

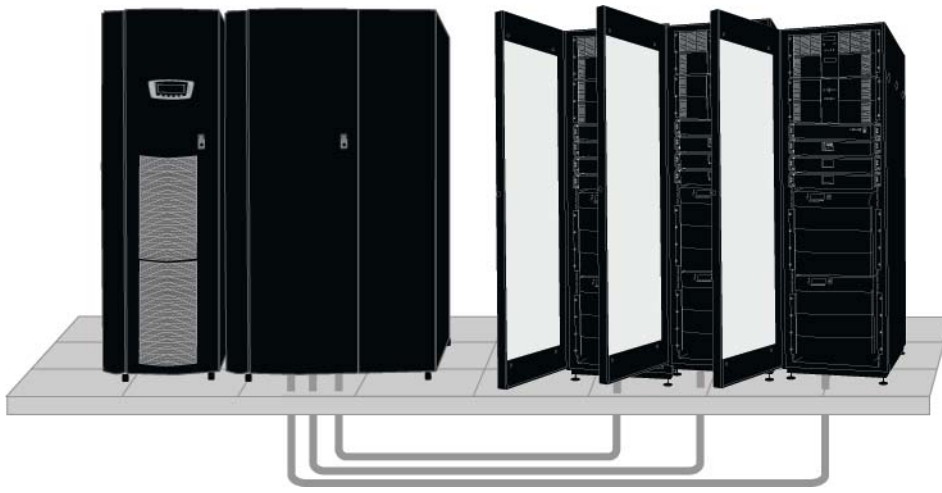

Typical application of 9390 Integrated Distribution Cabinet distributing power to IT racks.

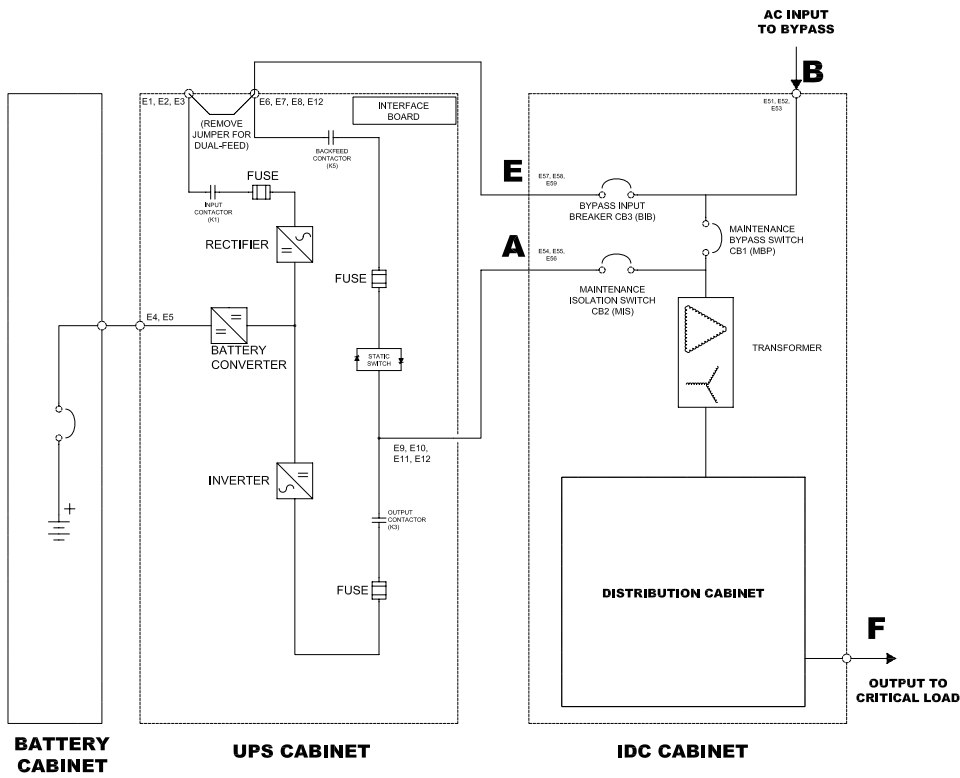

480V input and 208/120V output with BIB.

Integrated Accessory Cabinets for customizable configurations

Eaton offers several configurations of Integrated Accessory Cabinets (IAC) for use with the 9390 UPS. Major functions of the IAC include: maintenance bypass, parallel tie capability and power distribution with combinations up to (2) 42-pole panelboards and (6) sub-feed breakers per IAC.

The IAC is primarily available in two forms – either a 200 mm (8”) sidecar bolted to the UPS (maintenance bypass or tie) or a 570 mm (22.5”) free-standing cabinet (maintenance bypass, tie or distribution). The size of the IAC is primarily dependant on function and rating.

IAC-SB and IAC-B Maintenance bypass

Maintenance bypass configuration (MBP) and maintenance isolation (MIS) breakers enable power to completely bypass the UPS power module. The module can then be serviced safely or replaced without interrupting power to critical systems. An optional bypass breaker (BIB) and rectifier input breaker (RIB) provide a single wiring point input to the UPS as well as a convenient method for removing power from the UPS when using maintenance bypass to supply the load.

Features

- Line and match design
- Two, three or four-breaker maintenance bypass
- No internal transformers
- Smallest cabinet ships bolted to UPS (IAC-SB)
- Large cabinet can be remotely located (IAC-B)

IAC-ST and IAC-T Tie Cabinet

- Parallel UPS tie cabinet (redundant). See one-line diagram on next page.
- Two-breaker tie with maintenance bypass (IAC-T only)
- Two-breaker tie-with main output
- Two-breaker tie
- Wall-mounted maintenance bypass, tie and distribution panels are also available

IAC-D Distribution Cabinet

- Used to add (2) additional 42-pole panelboards
- Or
- (1) 42-pole panelboards and up to (3) 250A distribution breakers
- Or
- Up to (6) 250A distribution breakers
- Line and match or remote
- Casters and leveling feet
- Panelboards come with individual 225A main breaker
- Neutral rated for harmonic loads (200%)
- Distribution breakers are Eaton JG electronic trip
 - Two electronic sensors available 100A and 250A
 - 100A settings 40-100A trip (eight settings)
 - 250A setting 100-250A trip (eight settings)



80 kVA 208 & 480V IAC-SC
160 kVA 208V IAC-B
160 kVA 480V IAC-SC

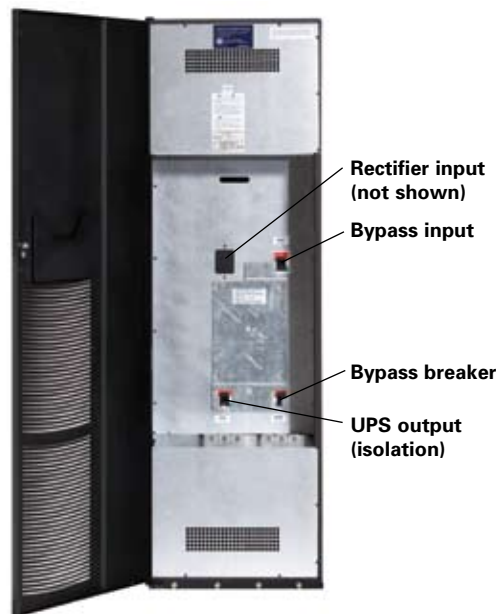

IAC-B Maintenance bypass (160 kVA)

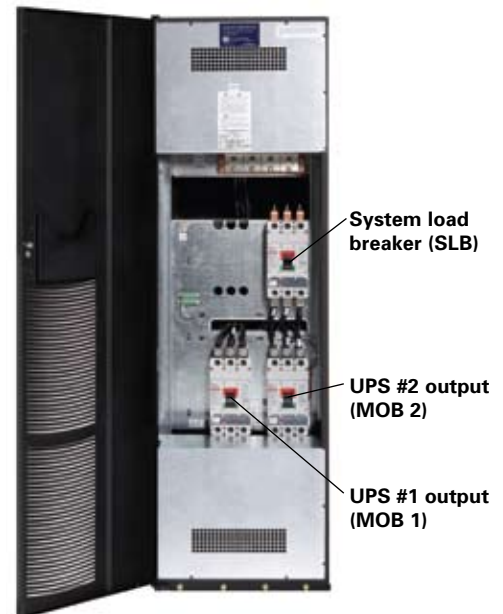

IAC-T Parallel Tie Cabinet

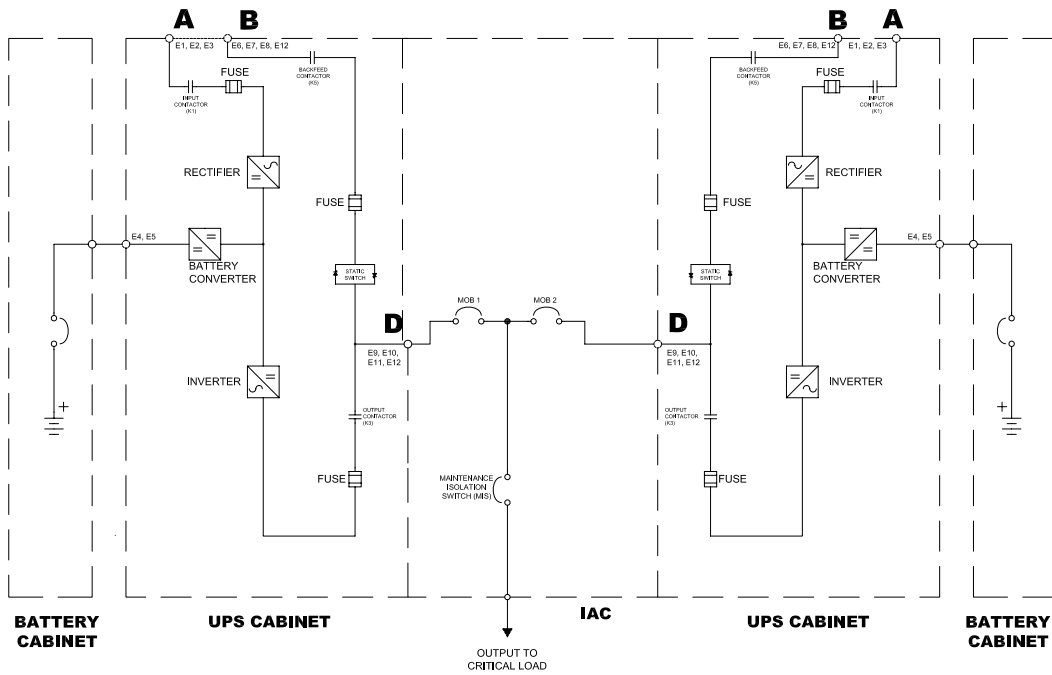

Two UPS parallel configuration with 8-inch sidecar tie cabinet

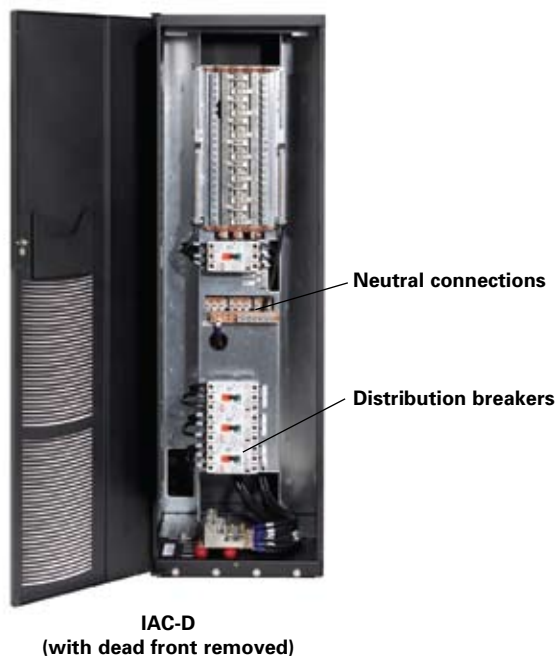
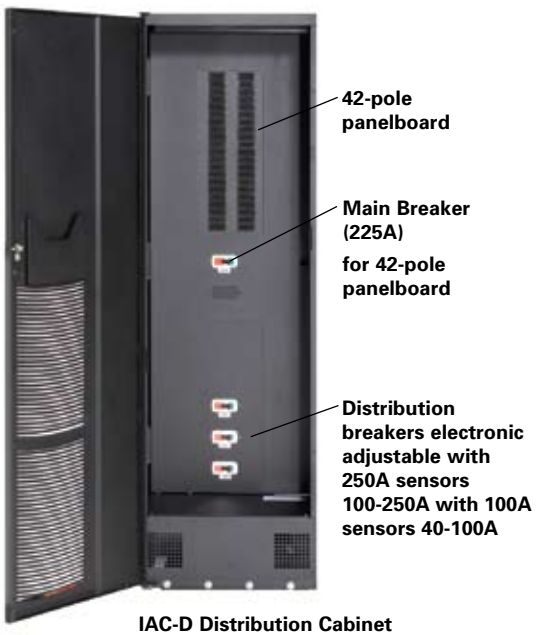

Power Distribution Unit (PDU)

The Eaton PDU provides reliable data center power distribution for both raised and non-raised floor applications. To ensure the high performance required for today's data centers, this Eaton-designed and manufactured PDU provides the following in an integrated, factory-tested package:

- State-of-the-art metering
- Isolation
- Voltage transformation
- Electrical distribution
- Equipment protection
- Computer-grade grounding

Additionally, when compared to hard-wiring methods, the PDU greatly shortens installation time and allows for easy relocation of equipment during consolidation, upgrade, or relocation of the data center. The PDU offers a broad range of options that present customized power distribution solutions for each customer's data center.

Its state-of-the-art metering system provides monitoring, alarming, and remote communications provisions to enable proactive power distribution management in the data center. Eaton's world-class service organization supports the PDU throughout the entire life cycle of your data center, increasing reliability and providing you with peace of mind.

Monitoring and connectivity

Eaton PDUs are equipped with the Energy Management System (EMS). The EMS provides state-of-the-art monitoring and alarming provisions that allow you to monitor power consumption and quality, manage and plan power needs, and react quickly to any potential problems down to the branch circuit level. Comprehensive connectivity options enable secure, remote power management, real-time system status information and network connectivity with the optional Power Xpert Gateway interface card. The latest technology is employed by the monitoring system, which includes an 8" x 40" LCD for clarity, a soft-key driven menu for ease of use, and audio/visual indicators that provide alarming and status updates.

Power consumption trends for up to 24 months can be viewed through a history log—a powerful aid in capacity planning and diagnosis as events are time- and date stamped as they occur. Custom alarm settings may be programmed at the factory, by the user or by our service organization.

In addition, Eaton's optional branch circuit monitor within the EMS continuously measures the current on branch circuits and warns of impending trouble, so you can take proactive action. The branch circuit monitoring system assesses circuit activity 7x24 and provides time-stamped metering, alarm and statistical information for each branch circuit. You receive significant information that is needed to effectively manage your entire power distribution system. Armed with these insights, data center and facilities managers can more effectively manage energy consumption to prevent overload conditions, optimize power distribution, and when applicable, accurately bill internal customers for power usage.



300 kVA PDU with optional sidecar and Energy Management System (EMS)



A 24-month history log provides a powerful aid in capacity planning and diagnosis.

A closer look inside the 9390

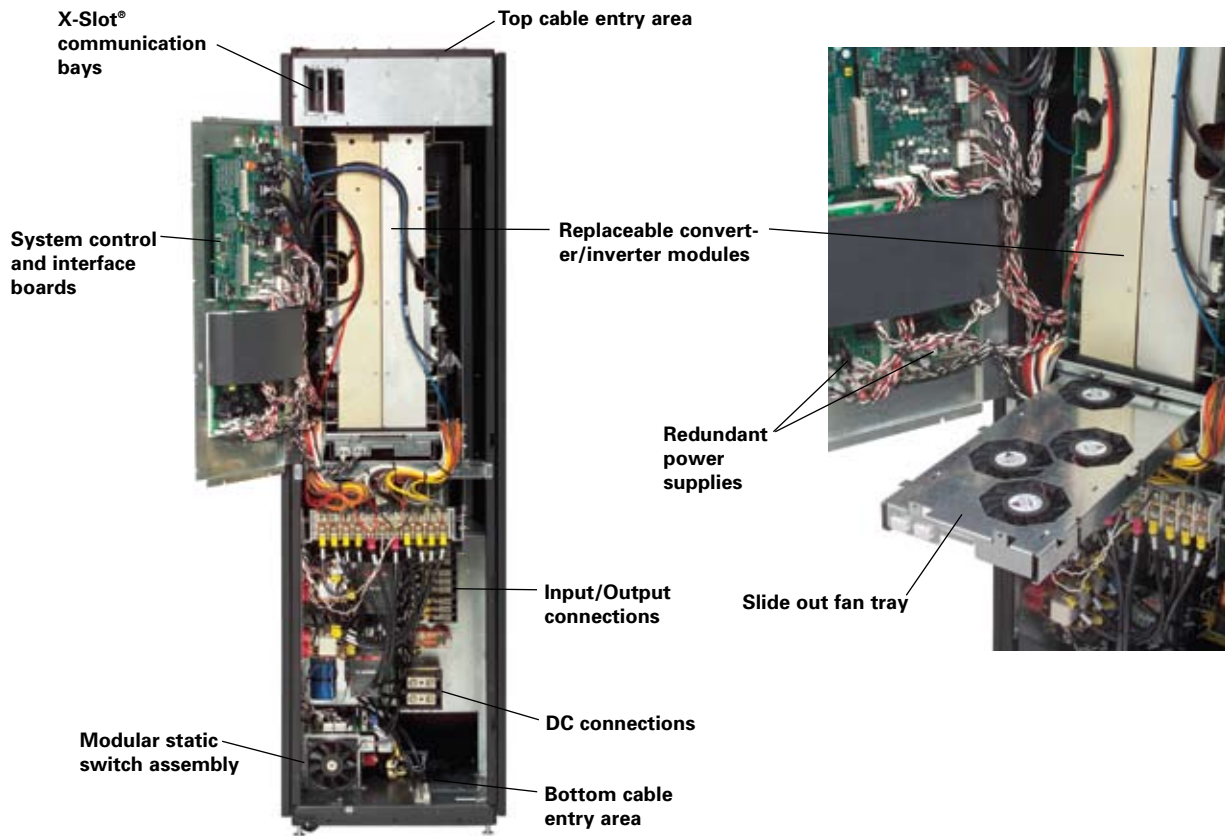

80 kVA

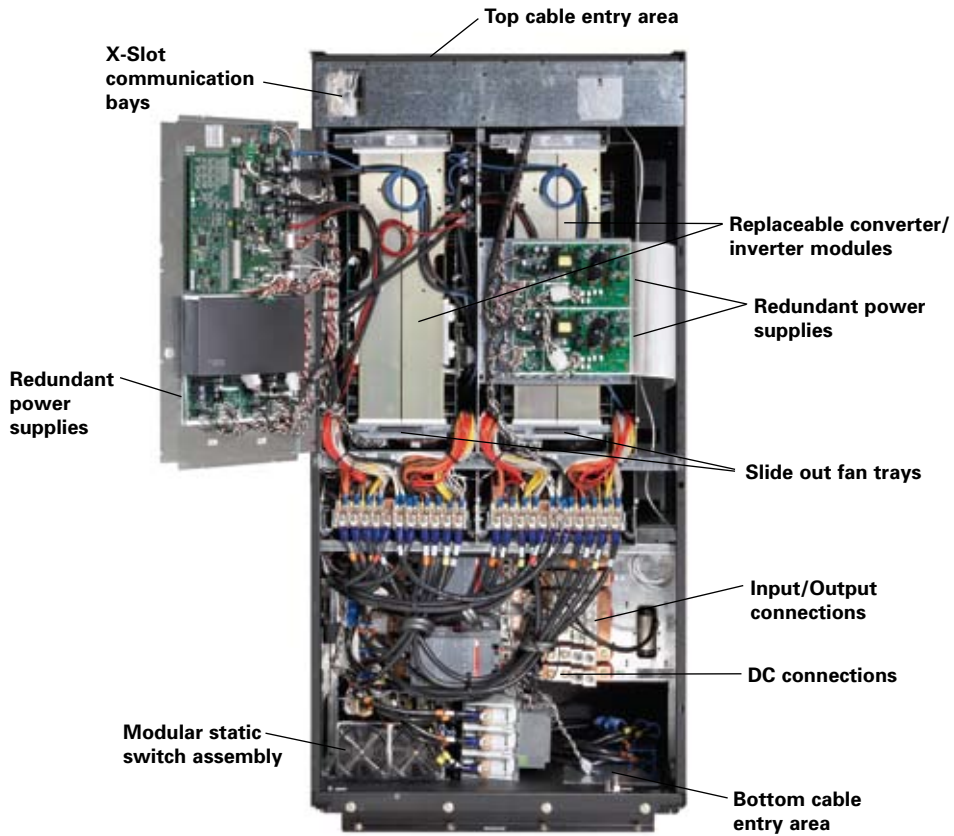

160 kVA

Flywheel integration

As an alternative to conventional batteries, the 9390 is flywheel compatible. (A flywheel stores kinetic energy well suited for high-power, short-discharge applications.) This system features excellent reliability and an advanced control system that enable the flywheel to charge and discharge at high rates for countless cycles—for 100% availability of power and an alternative to conventional batteries.

Flywheel features and benefits

- Green technology – eliminates lead use in facility (batteries), reduces energy consumption
- Longer useful life (20 years versus average of five years for batteries)
- Space savings
- Ease of installation – small footprint, no floor load concerns, no burden on temperature control systems, no hazardous materials
- Reliability – flywheel systems can be used in conjunction with batteries as needed to provide a critical backup for battery systems

Eaton delivers a new level of confidence

The culmination of 40 years of R&D excellence, the 9390 means confidence—confidence that your organization’s critical systems are protected by the most reliable, efficient, and full-featured protection available, and confidence that Eaton will be there with you for the long term with premium warranty coverage and expert technical support.

To find out more, visit our Web site at www.powerware.com/9390, or contact us at 1.800.356.5794.



VDC-XE Flywheel



VDC-XE Flywheel with doors open

Flywheel module

DC disconnect circuit breaker

Field-serviceable vacuum pump

Accessory cabinet dimensions and weight

Accessory cabinet	IBC-S	IBC-L	IAC-B	IAC-T
20-80 kVA (H"xW"xD")	22.5 x 31.6 x 73.7	42.7 x 31.6 x 73.7		22.5 x 31.6 x 73.7
20-80 kVA (weight)	Up to 2445 lbs	Up to 4835 lbs		Up to 540 lbs
100-160 kVA (H"xW"xD")	22.5 x 31.6 x 73.7	42.7 x 31.6 x 73.7	22.5 x 31.6 x 73.7	22.5 x 31.6 x 73.7
100-160 kVA (weight)	Up to 2445 lbs	Up to 4835 lbs	Up to 700 lbs	Up to 700 lbs
Accessory cabinet	IAC-D	M90 MBS	MTC	
20-80 kVA (H"xW"xD")	22.5 x 31.6 x 73.7	Up to 24 x 73 x 11.5	Up to 36 x 90 x 11.5	
20-80 kVA (weight)	Up to 420 lbs	Up to 500 lbs	Up to 500 lbs	
100-160 kVA (H"xW"xD")	22.5 x 31.6 x 73.7	Up to 36 x 90 x 11.5	Up to 36 x 90 x 11.5	
100-160 kVA (weight)	Up to 420 lbs	Up to 775 lbs	Up to 775 lbs	

IDC technical specifications¹

9390 Integrated Distribution Cabinet

General characteristics

Installation	Line up and match to UPS Front access only
Color	Same as UPS
Construction	NEMA 1 ventilated
Input voltage	208, 480V

Output voltage

Isolation	208, 208/120V
Distribution	208/120V

Dimensions and weight

20 - 80 kVA	HxWxD: 73.7 x 35.6 x 31.6 in./1872 x 904 x 803 mm
20 - 80 kVA weight	1200 lb. (maximum)
100 - 160 kVA	HxWxD: 73.7 x 42.7 x 31.6 in./1872 x 1085 x 803 mm
100 - 160 kVA weight	2185 lb. (maximum)

Certification

Safety	UL 1778
Markings	UL, CUL

User interface

Cable entry	Top or bottom
Remote monitoring	Optional

Transformer option

Electrostatic shield	Standard
Insulation	150°C Rise, Class H
Impedance	5% (maximum)
K-factor	K-1 (standard); K13, K20 (optional)
Compensation taps	2-FCAN, 4-FCBN standard
Overload protection	Standard

Power distribution option - Panelboard distribution

Quantity	2 (maximum)
Voltage	208/120V
Main breaker	225A, 65 kAIC
Circuits	84 (maximum)
Distribution breakers	(in lieu of panelboards)
Quantity	6 (maximum)
Voltage	208/120V
Size	250A, 65 kAIC, adjustable trip

Maintenance bypass option

Maintenance bypass	Optional; 2, 3 or 4 breaker configuration
--------------------	---

1. Due to continuing product improvements, specifications are subject to change without notice.

Technical specifications¹

Eaton 9390 UPS

UPS rating (0.9 power factor)

kVA	20	30	40	50	60	80	100	120	160
kW	18	27	36	45	54	72	90	108	144

General characteristics

Efficiency	Up to 94%
Parallel capability	6x modules w/o tie cabinet; 8x with tie cabinet
Audible noise	<65 dBA @ 1 meter
Altitude (max)	2000m at 40°C, 104°F

Input characteristics

Voltage	208, 380, 400, 415, 480, 600 ²
Voltage range	+10% / -15% ³
Frequency range	55-65 Hz
Power factor	0.99 (min)
Input current distortion	<4.5% (no input filter required)
Soft start capability	Yes
Internal backfeed protection	Yes
Broadcast global support	Yes

Output characteristics

Voltage	208 ⁴ , 380 ⁴ , 400 ⁴ , 415 ⁴ , 480 ⁴ , 600 ⁵
Regulation	±1%
Inverter	PWM with IGBT switching
Voltage THD	<2% (100% linear load); <5% (non-linear load)
Load power factor range	Down to 0.9pf leading without de-rating
Heat dissipation (BTU/Hr x 1000/Hr)	80 kVA, 208V: 23.6 160 kVA, 208V: 47.3 80 kVA, 380-480V: 21.9 160 kVA, 380-480V: 43.8

Battery

Battery types	VRLA, AGM, Gel, Wet, Eaton batteries also available
Battery voltage	384-480V
Temperature compensation	Optional
Charging method	Advanced battery management
Heat dissipation	<48 BTU @ full load

Dimensions and weights

40-80 kVA modules	HxWxD: 73.7 x 18.9 x 31.6 in./ 1872 x 480 x 803 mm
120-160 kVA modules	HxWxD: 73.7 x 35.6 x 31.6 in./ 1872 x 904 x 803 mm
40-80 kVA modules	640 lb./290 kg (208V); 568 lb./ 258 kg (480V)
100-160 kVA modules	1,060 lb./481 kg (208V, 480V)

UNITED STATES
8609 Six Forks Road
Raleigh, NC 27615 U.S.A.
Toll Free: 1.800.356.5794

www.eaton.com/powerquality

CANADA
Ontario: 416.798.0112
Toll free: 1.800.461.9166

LATIN AMERICA
Argentina: 54.11.4124.4000
Brazil: 55.11.3616.8500
Caribbean: 1.949.452.9610
Mexico & Central America:
52.55.9000.5252
South Cone: 54.11.4343.6323

Serviceability

Back/side against wall installation	Standard
-------------------------------------	----------

Optional accessories

Module tie cabinet
External maintenance bypass
Integrated distribution cabinet
Isolation transformer

Certification

Safety	UL1778, cUL
EMC	IEC62040-2 EN50091 Class A (restricted access)
Surge	ANSI C62, 41 Cat, A&B

eNotify Remote Monitoring service

7x24 remote monitoring of UPS and battery alarms, daily heartbeat check and monthly report required. ConnectUPS-X Web/SNMP Card and Environmental Monitoring Probe are included with enrollment. Please visit www.powerware.com/enotify for more information.

Communications

Software compatibility - PowerVision, LanSafe, FORESEER, Power Xpert Communications cards - Standard system includes one ConnectUPS Web/SNMP-X Card with an Environment Monitoring Probe. Two communications bays standard. Maximum of four communication bays with the communication expansion option.

The following connectivity options can be installed at any time:

- Modus Card
- Relay Interface Card (Use for AS400s)
- Industrial Relay Card (5A@120V)
- Hot Sync CAN Bridge Card provides CAN communications, isolated RS-485 port
- Environmental Monitoring Probe (EMP)

Remote inputs/outputs - two building alarms inputs and on summary alarm contact (5A@120V) standard

Four more building alarm inputs available with the Communications Expansion Option Remote panel - eight backlit status indicator lamps plus an audible horn

*See the Limited Factory Warranty for 9390 products for details. Batteries are warranted by the battery manufacturer and not by Eaton.

**Requires the Parallel Card option (RS-485 port) and requires an external 120V power supply to drive the remote monitor panel.

1. Due to continuing improvements, specifications are subject to change without notice.
2. 600V applications require an input transformer.
3. At full load without battery discharge.
4. Output transformers are required if the desired output voltage is not the same as the input voltage.
5. 600V applications require an output transformer.



EUROPE/MIDDLE EAST/AFRICA
Denmark: 45.3686.7910
Finland: 358.94.52.661
France: 33.1.6012.7400
Germany: 49.0.7841.604.0
Italy: 39.02.66.04.05.40
Norway: 47.23.03.65.50
Portugal: 55.11.3616.8500
Sweden: 46.8.598.940.00
United Kingdom: 44.1753.608.700

ASIA PACIFIC
Australia: 61.2.9693.9366
New Zealand: 64.0.3.343.3314
China: 86.21.6361.5599
HK/Korea/Taiwan: 852.2745.6682
India: 91.11.4223.2300
Singapore/SEA: 65.6825.1668

Eaton, Powerware, Powerware Hot Sync, ABM, PowerTrust, PowerChain Management, Power Xpert, LanSafe, PowerVision, Foreseer and X-Slot are trade names, trademarks, and/or service marks of Eaton Corporation or its subsidiaries and affiliates. All other trademarks are property of their respective owners.



Powering Business Worldwide

©2009 Eaton Corporation
All Rights Reserved
Printed in USA
9390FXA
January 2009